

BROCHURE

E5061B Network Analyzer

100 kHz to 1.5 GHz/3 GHz

5 Hz to 500 MHz/1.5 GHz/3 GHz



E5061B Responds to Various Measurement Needs, From LF to RF

The Keysight Technologies, Inc. E5061B is a member of the industry standard ENA Series network analyzers. The E5061B addresses a broad range of measurement needs of electronic components and circuits from low to high frequencies. The E5061B is the ideal solution for applications in industries such as wireless communications, aerospace and defense, computer, medical, automotive, CATV, plus many more. The E5061B now provides a new standard of frequency-domain device analysis from 5 Hz to 3 GHz.

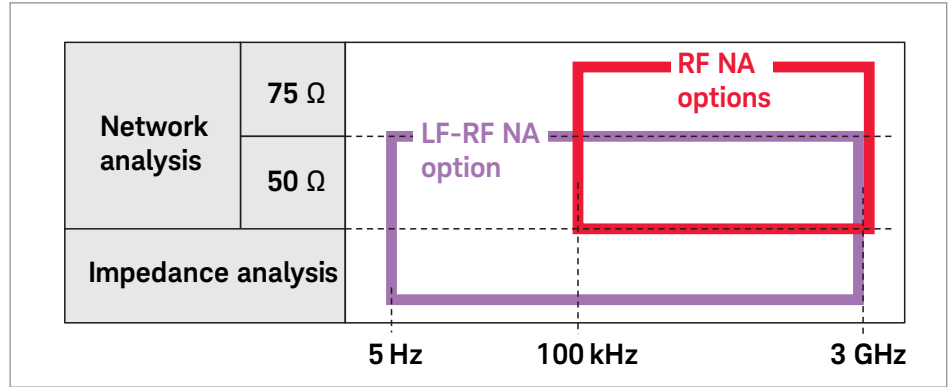

RF NA options

E5061B-115/215/135/235: 50 Ω

E5061B-117/217/137/217: 75 Ω

Economy RF network analyzer that offers solid performance for basic RF network measurements

- 100 kHz to 1.5 GHz/3 GHz
- Transmission/Reflection test set and S-parameter test set
- 50 Ω and 75 Ω system impedance
- Wireless power transfer analysis function (Option 006)²



LF-RF NA options

E5061B-3L3/3L4/3L5

General-purpose network analyzer with comprehensive functionality to support network and impedance measurements for electronic devices from LF to RF

- 5 Hz to 500 MHz/1.5 GHz/3 GHz
- 50 Ω S-parameter test set
- Gain-phase test port (1 M Ω /50 Ω inputs)
- DC bias source
- Impedance analysis function (Option 005)¹
- Wireless power transfer analysis function (Option 006)

1. Option 005 impedance analysis function is not applicable on the RF NA Options E5061B-1x5/2x5/1x7/2x7.
 2. Option 006 wireless power transfer analysis function is not applicable on the RF NA Options E5061B-1x5/1x7/2x7.

Advanced Measurement Capabilities in a Compact Box

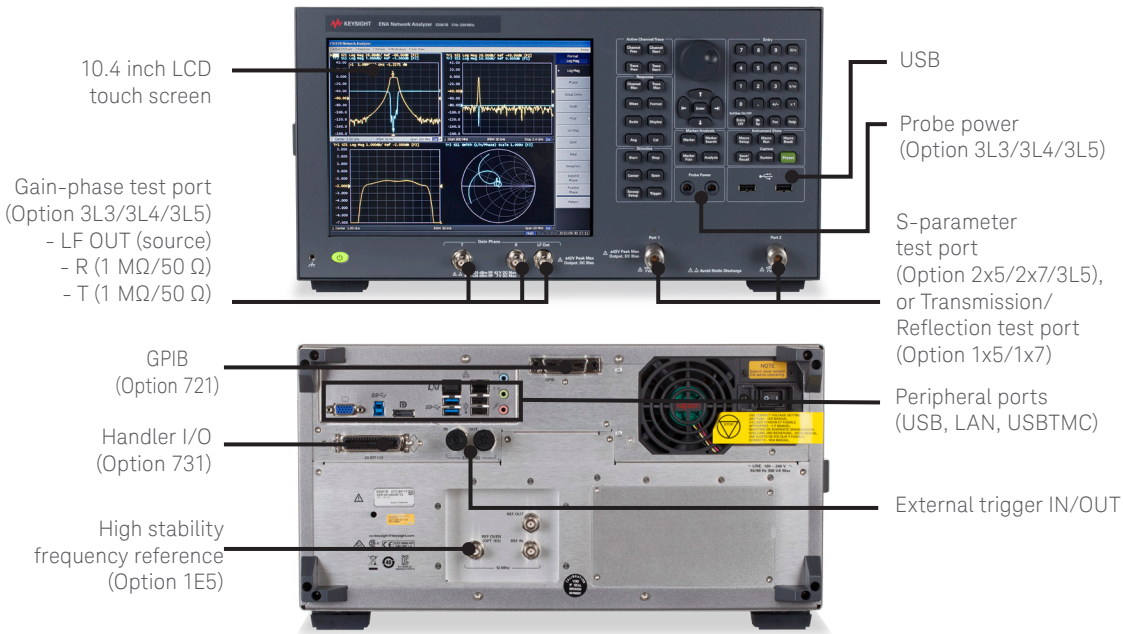

Table 1. E5061B key measurement functions

| | RF NA options (E5061B-1x5/2x5/1x7/2x7) | LF-RF NA option (E5061B-3L3/3L4/3L5) |
|---|--|---|
| Test frequency range | 100 kHz to 1.5 GHz (Option 115/215/117/217) 100 kHz to 3 GHz (Option 135/235/137/237) | 5 Hz to 500 MHz (Option 3L3) 5 Hz to 1.5 GHz (Option 3L4) 5 Hz to 3 GHz (Option 3L5) |
| Source output level | -45 to +10 dBm (at 300 kHz to 1.5/3 GHz) -45 to +5 dBm (at 100 kHz to 300 kHz) | -45 to +10 dBm (at 5 Hz to 3 GHz) |
| Dynamic range | >120 dB (at 1 MHz to 1.5/3 GHz, IFBW = 10 Hz) | >120 dB (at 1 MHz to 3 GHz, IFBW = 10 Hz) |
| Trace noise | 5 mdBrms (IFBW=3 kHz) | 5 mdBrms (IFBW=3 kHz/Auto) |
| Test port | Transmission/Reflection (Option 1x5/1x7), or S-parameter test port (Option 2x5/2x7) | S-parameter test port (5 Hz to 500 MHz/1.5 GHz/3 GHz), plus Gain-phase test port (5 Hz to 30 MHz) |
| 75 Ω test port | Yes (option 1x7/2x7) | No |
| 1 M Ω input | No | Yes (Gain-phase test port, 1 M Ω // 30 pF) |
| Probe power | No | Yes |
| DC bias source | No | Yes (0 to \pm 40 Vdc, max. 100m Adc, sweepable) |
| Impedance analysis function | No | Yes (Option 005) |
| Wireless power transfer analysis function | Yes (Option 006) ¹ | Yes (Option 006) |
| Frequency stability (CW accuracy) | \pm 7 ppm \pm 1 mHz (standard), \pm 1 ppm \pm 1 mHz (option 1E5) | |
| Time domain/Fault location analysis | Yes (option 010, with Time gating and Structural Return Loss analysis functions) | |
| Number of channels/traces | 4-channel/4-trace | |
| Number of point | 1601 points | |
| IFBW | 1 Hz to 300 kHz, plus IFBW Auto mode (Option 3L3/3L4/3L5) | |
| Calibration capabilities | Response, 1-port full, 2-port full ² , Enhanced response, Adapter removal, Auto port extension Ecal (at >300 kHz with RF 2-port Ecal modules) Impedance calibration and fixture compensation (Option 3L3/3L4/3L5 + 005) | |
| Data analysis, data processing | Equation editor, VBA programming, Limit test, Z-conversion | |

1. Not available with E5061B-1x5/1x7/2x7.

2. Not available with E5061B-115/135/117/137.

RF NA Options (100 kHz to 1.5/3 GHz)

E5061B-115/215/135/235: 50 Ω,
E5061B-117/217/137/237: 75 Ω

Solid performance in an enhanced platform

The E5061B RF NA options provide high-performance 1- and 2-port network analysis at an affordable price. The established RF performance of the E5061/62A has been integrated into this new digital platform. A wide variety of test set options allows you to select the best configuration to suite your test requirements and budget. Enhanced digital processing capabilities and a smaller footprint improve the throughput and efficiency for testing RF components, including cellular BTS filters/antennas, MRI coils, RFIDs, CATV components, and more.

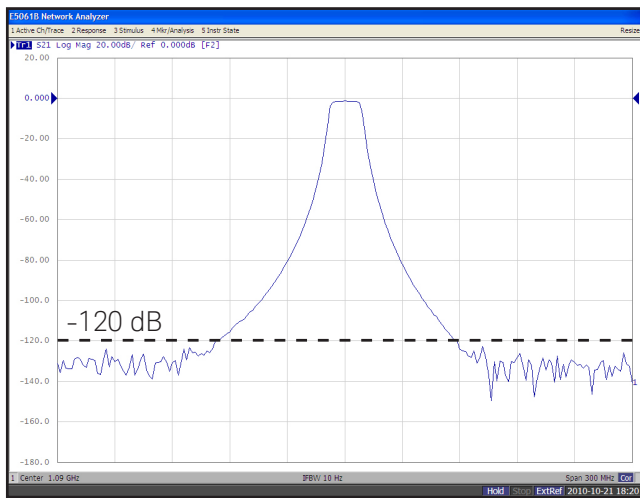

Wide dynamic range for RF filter measurement
(F0 = 1.09 GHz, source = 10 dBm, IFBW = 10 Hz)

Expanded frequency range

An expanded lower-end frequency range down to 100 kHz allows you to test components that require measurements in the 100 kHz range, such as LAN filters and automotive antennas.

Time domain/Fault location analysis (Option E5061B-010)

The time gating function is available in the time domain/fault-location analysis function. This enables you to eliminate mismatch errors caused by test fixtures when testing CATV cables.

| Transmission/Reflection test set | S-parameter test set |
|----------------------------------|----------------------|
| #115 : 1.5 GHz, 50 Ω | #215 : 1.5 GHz, 50 Ω |
| #135 : 3 GHz, 50 Ω | #235 : 3 GHz, 50 Ω |
| #117 : 1.5 GHz, 75 Ω | #217 : 1.5 GHz, 75 Ω |
| #137 : 3 GHz, 75 Ω | #237 : 3 GHz, 75 Ω |

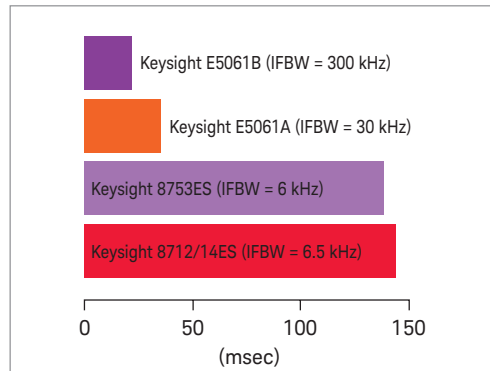
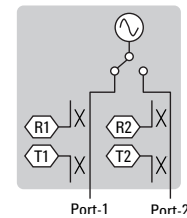
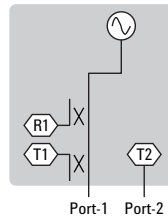

Sweep speed comparison (201 points, 2-port cal, max IFBW)

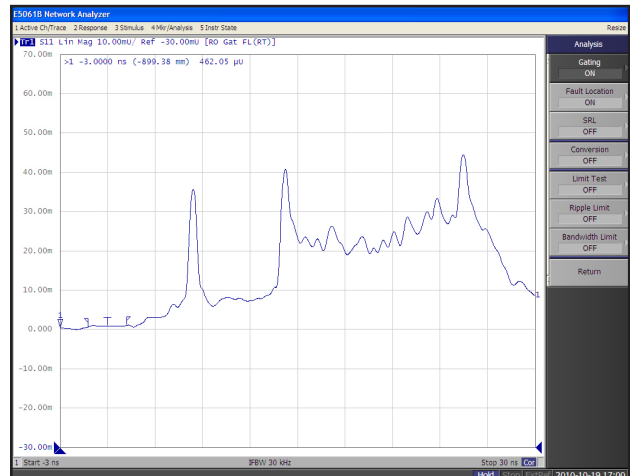

Time domain analysis for cable

LF-RF NA Option (5 Hz to 500 MHz/ 1.5 GHz/3 GHz) E5061B-3L3/3L4/3L5

Comprehensive LF-to-RF network analysis

The E5061B-3L3/3L4/3L5 LF-RF NA option offers versatile network analysis in the broad frequency range from 5 Hz to 500 MHz/1.5 GHz/3 GHz. Comprehensive LF network measurement capabilities including built-in 1 MΩ inputs have been seamlessly integrated with the high-performance RF network analyzer. The E5061B-3L3/3L4/3L5 is the right solution for component and circuit evaluations in the R&D environment.



S-parameter test port

The built-in S-parameter test set of the E5061B-3L3/3L4/3L5 covers 5 Hz to 500 MHz/1.5 GHz/3 GHz with excellent dynamic range performance. This allows you to evaluate a variety of devices from near DC to RF ranges.

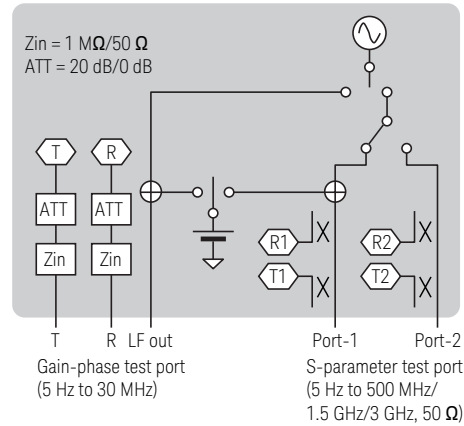

Gain-phase test port

The gain-phase test port provides direct receiver access for LF applications from 5 Hz to 30 MHz. The built-in 1 MΩ inputs allow you to easily perform in-circuit probing measurements for amplifiers and DC-DC converter control loops¹. The receiver ports can accurately measure amplifier's CMRR/PSRR and PDN milliohm impedance by eliminating the measurement errors associated with the ground loop.

DC bias source

The E5061B-3L3/3L4/3L5 has a built-in DC bias source which internally superimposes the DC voltage up to ±40 Vdc onto the AC source signal at port-1 or LF OUT port. Also, it is possible to provide only the DC voltage from LF OUT port while measuring a DUT at the S-parameter test port.

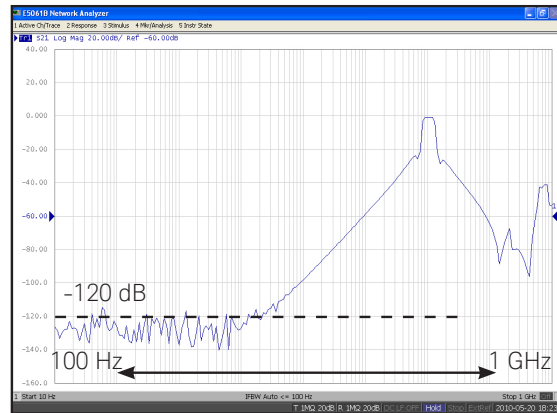

Wide-band S21 measurement with S-parameter test port

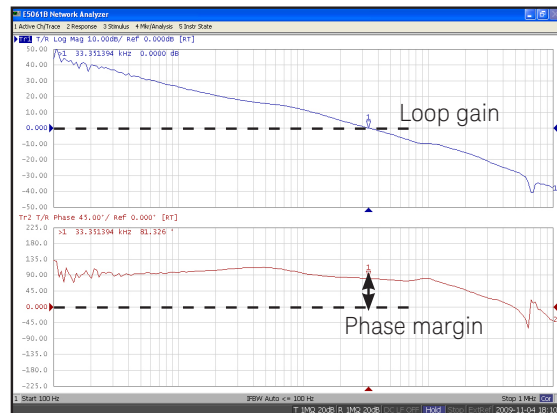

DC-DC loop-gain measurement

1. For more information, please see the the application note *Evaluating DC-DC Converters and PDN with the E5061B LF-RF Network Analyzer*, publication 5990-5902EN

LF-RF NA Option (5 Hz to 500 MHz/1.5 GHz/3 GHz) E5061B-3L3/3L4/3L5 + 005 Impedance Analysis Option

NA plus ZA in one box

The E5061B-005 provides the impedance analysis (ZA) firmware for the E5061B-3L3/3L4/3L5 LF-RF network analyzer. This option enables the analyzer to measure impedance parameters of electronic components such as capacitors, inductors, and resonators. The combination of NA and ZA capabilities further enhances the analyzer's versatility as a general R&D tool. Basic ZA functionalities including fixture compensation and equivalent circuit analysis are supported by the firmware. The DC biased impedance measurement is possible with the built-in DC bias source provided by the E5061B-3L3/3L4/3L5¹.

Wide application coverage

The E5061B-005 supports reflection, series-thru, and shunt-thru methods using the S-parameter test port or gain-phase test port. These methods are ideally suitable for low-to-middle, middle-to-high, and very low milliohm impedance ranges. You can evaluate a broad range of components by selecting appropriate measurement methods.

Test fixtures

For the port-1 reflection method and the gain-phase series-thru method, you can use Keysight's 7 mm and 4TP (4-terminal-pair) component test fixtures. The 7 mm fixtures are connected to the port-1 via the 16201A terminal adapter, and the 4TP fixtures are directly connected to the gain-phase test port.

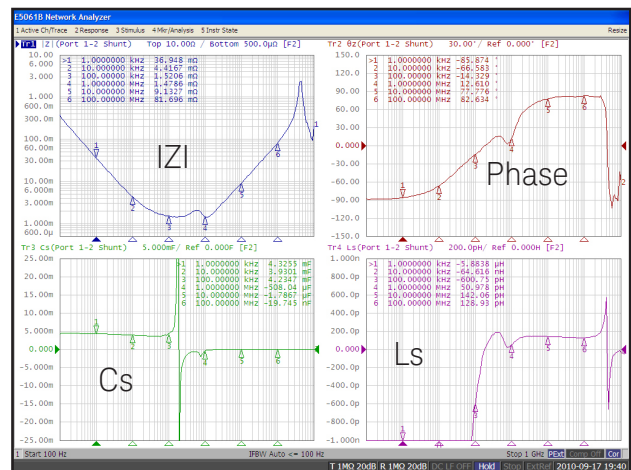
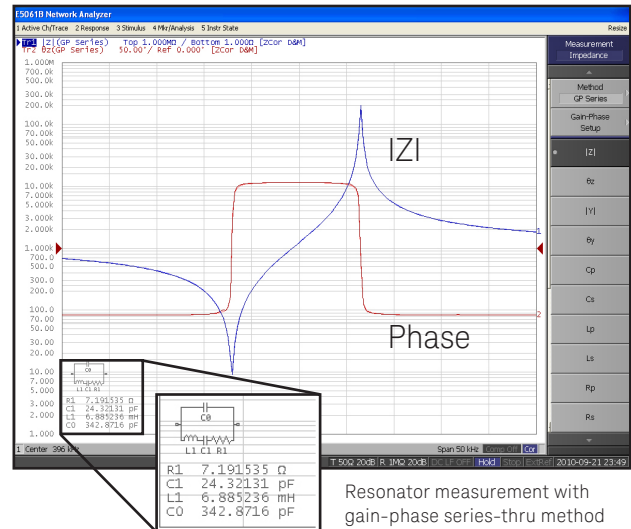

Port-1 reflection method using 16201A terminal adapter and 16092A 7 mm type fixture

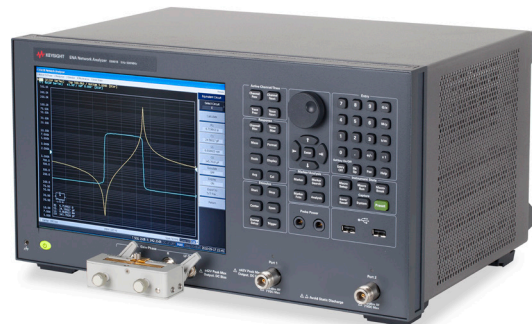

1. For more about the impedance analysis with the E5061B, please see the application note: Performing Impedance Analysis with the E5061B ENA Vector Network Analyzer, publication 5991-0213EN

E5061B-006 Wireless Power Transfer Analysis Option

Power transfer efficiency between coils or resonators is one of the key factors to improve the performance of wireless power transfer systems. The Keysight E5061B offers option 006¹ wireless power transfer analysis software to measure wireless power transfer efficiency between coils or resonators. In addition, option 3L3/3L4/3L5 and 005 add power integrity and impedance measurement capabilities to achieve combination analysis in

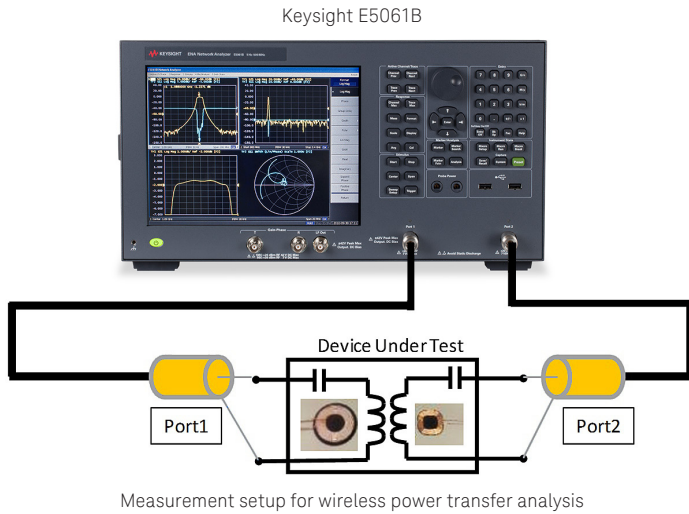

Real-time wireless power transfer efficiency measurements

- Display wireless power transfer efficiency between coils or resonators in real-time
- Capable of setting arbitrary load impedance

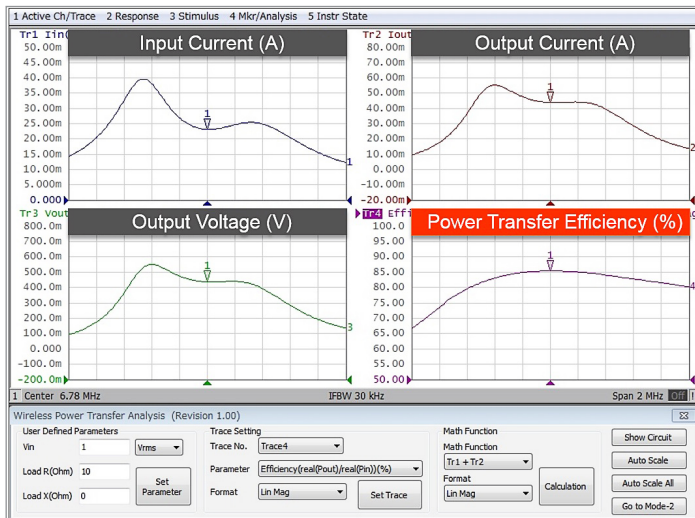

Real-time wireless power transfer analysis in Mode-1

Advanced simulation

- 2D/3D simulation to visualize dependency of load impedance
- Network analysis data output for further circuit modeling and simulation in Keysight ADS simulator

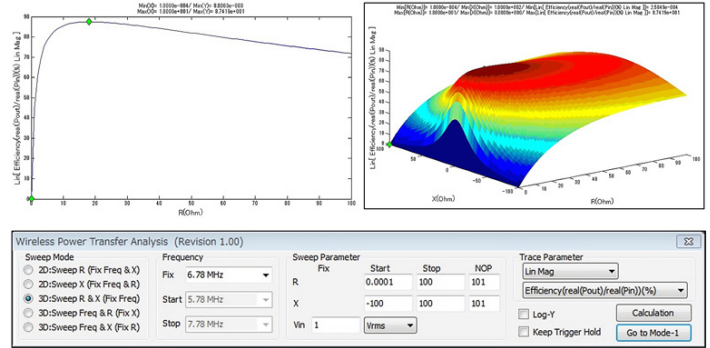

Advanced 2D/3D simulation in Mode-2

Combination analysis of power transfer, power integrity and impedance

- E5061B option 3L3/3L4/3L5 allows LF-RF network analysis from 5 Hz to 500 MHz/1.5 GHz/3 GHz
- E5061B option 005 adds impedance analysis function
- Wireless power transfer analysis, power integrity & impedance measurements in one-box



One-box solution for characterization of components in wireless power transfer systems

1. For more information, please see the application note Wireless Power Transfer (WPT) Measurements Using the ENA Vector Network Analyzer, publication 5992-0771EN
 2. Option 006 is not applicable for the E5061B RF NA options 1x5/1x7/2x7

Related Literature

E5061B ENA Vector Network Analyzer Data Sheet, 5990-4392EN

E5061B ENA Vector Network Analyzer Impedance Analysis Function Data Sheet and Configuration Guide, 5990-7033EN

Keysight Vector Network Analyzer Selection Guide, 5989-7603EN

Electronic Calibration (ECal) Modules for Vector Network Analyzer Technical Overview, 5963-3743E

Web Resources

www.keysight.com/find/vna

www.keysight.com/find/ecal

www.keysight.com/find/mta

www.keysight.com/find/benchvue

Learn more at: www.keysight.com

For more information on Keysight Technologies' products, applications or services, please contact your local Keysight office. The complete list is available at:

www.keysight.com/find/contactus

